

BOSE

Bose Work

CONFERRING, CLARIFIED.

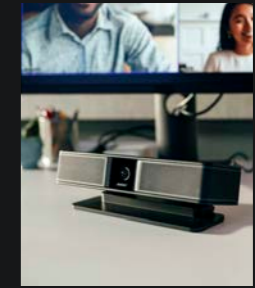

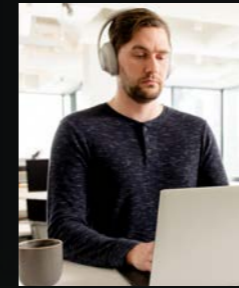

Feel together again.

The new era of hybrid work is here — and Bose Work is here to help. Hybrid work models mean some are in the building, some are remote — and everyone’s on calls all day. Conferencing keeps work moving. And Bose Work solutions bring the simplicity and clarity of Bose to conferencing.

Our products integrate seamlessly with existing platforms, bringing enhanced video and audio performance to popular third-party cloud services such as Microsoft Teams, Google Meet, Zoom, and more. In this new era of hybrid work, Bose Work solutions help teams feel more together and get more done.

DESKTOP & MOBILE CONFERENCING



Help remote and open-office workers feel more engaged with Bose Noise Cancelling Headphones 700 UC.

SMALL & MEDIUM CONFERENCE ROOMS



Simplify meeting spaces with all-in-one USB solutions like the Bose Videobar VB-S and VB1 — premium conferencing devices, perfect for huddle areas and small- and medium-sized rooms.

INTEGRATED MEETING ROOMS

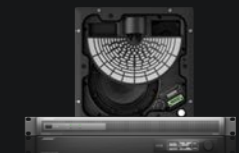

Design integrated meeting rooms using products like ControlSpace EX processors, ControlSpace EX Dante® endpoints, Bose loudspeakers, and ControlSpace Designer software.



BOSE VIDEOBAR VB-S

Make every meeting feel short and sweet.

Bring the Bose experience to small meeting spaces — huddle spaces, meeting booths, and rooms up to 3 × 3 m (10 × 10 ft) — with an all-in-one USB solution that installs quickly and easily and delivers premium audio and video performance

4 beam-steering microphones make conversation more natural by actively focusing on voices; exclusion zones help reject unwanted sound; and auto EQ delivers optimized audio to all participants

4K ultra-HD camera offers wide field of view, helping meeting participants communicate and be seen more clearly

Works with Microsoft Teams, Zoom, Google Meet, and other popular UC platforms

Autoframing Mode, ideal for groups: keeps all in-room participants in view

Follow-me Mode, ideal for a single presenter: frames and dynamically follows the presenter

Elegant, low-profile design made possible by renowned Bose engineering

Includes Bose Work Configuration software for easy initial setup, and **Bose Work Management software** for remote management



BOSE VIDEOBAR VB1

Sound? Natural. Video? Clear. Work? Better.

Bring the Bose experience to huddle spaces and medium-sized rooms up to 6 × 6 m (20 × 20 ft) with an all-in-one USB solution that installs quickly and easily and delivers premium audio and video performance

6 beam-steering microphones make conversation more natural by actively focusing on voices; exclusion zones help reject unwanted sound; and auto EQ delivers optimized audio to all participants

4K ultra-HD camera offers wide field of view, helping meeting participants communicate and be seen more clearly

Works with Microsoft Teams, Zoom, Google Meet, and other popular UC platforms

Autoframing Mode, ideal for groups: keeps all in-room participants in view

Proprietary Bose transducers deliver room-filling sound

 **Single-cable connectivity and elegant low-profile design** made possible by renowned Bose engineering

Includes Bose Work Configuration software for easy initial setup, and **Bose Work Management software** for remote management





BOSE NOISE CANCELLING HEADPHONES 700 UC

Work better, wherever.

Speak confidently and be heard clearly on conference calls — an adaptive four-microphone pickup system isolates your voice from surrounding noise, eliminating the mute/unmute shuffle and “... are you there?” struggle

Personalize your work environment with 11 levels of noise cancellation, from virtual silence — for times of focus — to open and ambient, so you can hear what’s going on around you

Stay reliably connected and easily switch between audio sources — the included, pre-paired Bose USB Link *Bluetooth*® module provides a dedicated wireless connection to your computer

Collaborate in person instantly with Conversation Mode, which allows you to hear people and your surroundings clearly without removing your headphones

Enhance the audio experience with third-party cloud services such as Microsoft Teams, Google Meet, Zoom, and more

Keep focused for hours with a comfortable, lightweight design, stainless-steel headband, and angled earcups



Bose USB Link *Bluetooth* module

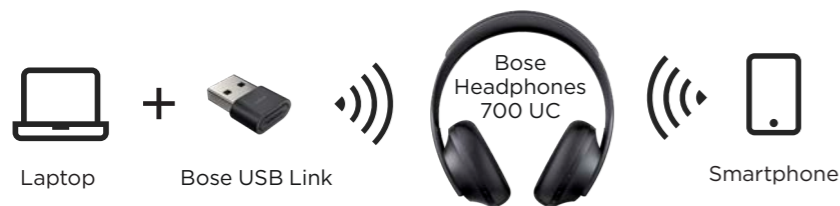
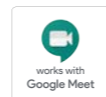

BOSE CEILING AUDIO SOLUTIONS

Work better, together.

Deliver a truly integrated premium conferencing solution, combining Bose loudspeakers (choose from the EdgeMax EM180 or DesignMax DM2C-LP), Sennheiser TeamConnect Ceiling 2 microphone, ControlSpace EX-440C processor, and PowerSpace P2600A amplifier

Clean up the conferencing experience with fewer devices on walls or tabletops, giving people the freedom to focus on work, the flexibility to sit or stand anywhere in the room, and the confidence that they’ll hear and be heard clearly

Choose from two systems — the innovative Bose ES1 system, featuring one EdgeMax EM180 loudspeaker, or the more conventional Bose DS4 system, featuring four DesignMax DM2C-LP loudspeakers

Bring clarity and intelligibility to large meeting rooms with superior echo-cancelling technology, so remote meeting participants can communicate freely and feel like they’re in the room

Deploy quickly with reference configurations that help reduce installation time

Combine with popular unified communications platforms such as Microsoft Teams, Zoom, and more, to provide enhanced audio performance in fully integrated meeting rooms

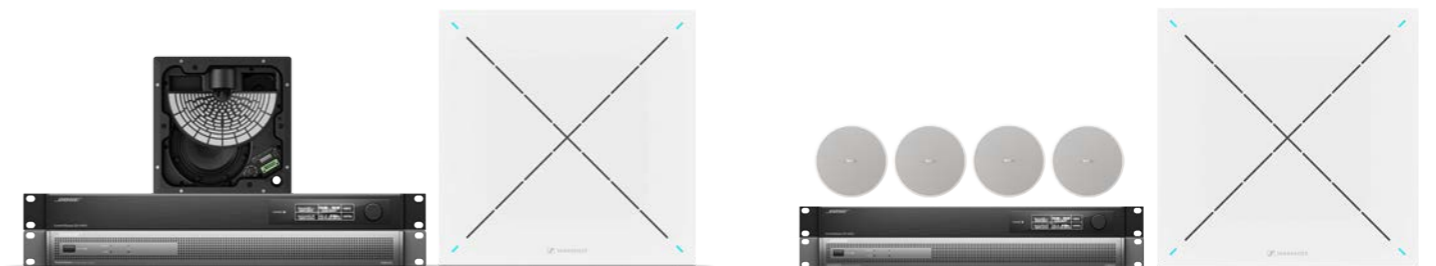

Bose ES1 system

Bose DS4

*Bose and Sennheiser products sold separately. Please contact your Bose or Sennheiser representative for more information.



Small spaces

For small spaces, Bose Videobar VB-S cleans up the conferencing experience with an elegant low-profile design, reducing clutter, and can be mounted easily in a variety of ways with the included table stand and wall-mount kit, or with a VESA mounting accessory (sold separately).



Medium-sized conference rooms

In medium-sized conference rooms — and even in acoustically challenging rooms with glass walls — Bose Videobar VB1 makes conversation natural. Six beam-steering microphones actively focus on voices and reject noise, and auto EQ delivers optimized audio to all participants.



Ideal for rooms up to 6 m (20 ft) long



Integrated meeting rooms 1

The Bose ES1 system* is a fully certified solution, ready for quick deployment and configuration of the electronics, reducing installation time. And it's more than fully integrated — it's truly integrated. Completely out of the way. With fewer devices on walls or tabletops, meeting participants can stand, sit, or move around the room freely

with the confidence that they'll hear and be heard. With the ES1 system, it's easier for teams to focus on ideas, move projects forward, and work better, together.

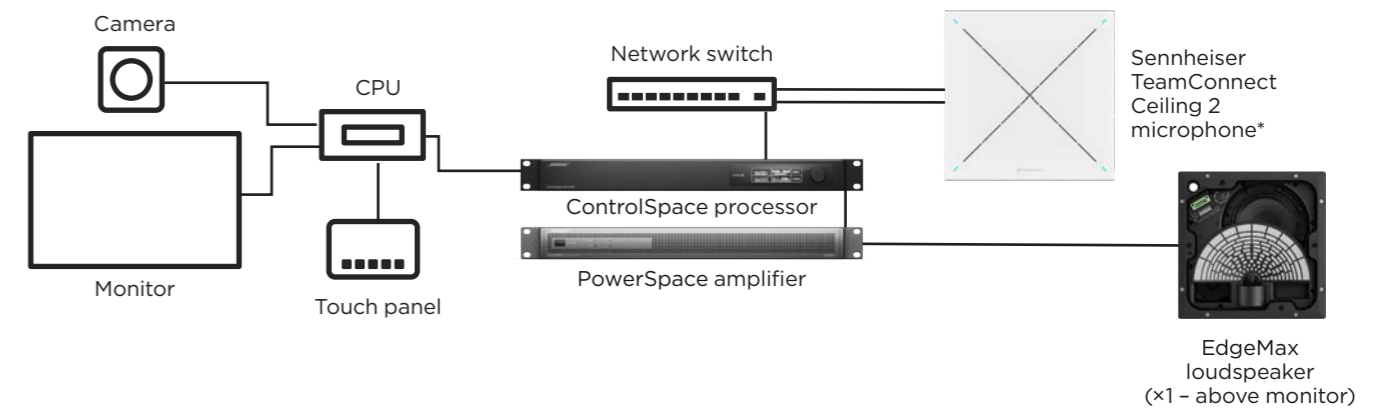

Integrated meeting rooms 2

With loudspeakers designed for vocal intelligibility and processors featuring specialized conference room algorithms, Bose Work solutions help keep the whole team on the same page. Beyond the ES1 system seen above, the Bose Work line of integrated conferencing products includes scalable solutions to fit virtually any large conference room, multi-room setup, or combine-and-divide-style room.

Integrators can choose from a wide range of products, combining Bose loudspeakers, amplifiers, endpoints, and processors to create perfectly tailored solutions that effectively cover a room of a given size, acoustic signature, ambient noise level, and more. Below is just one example.

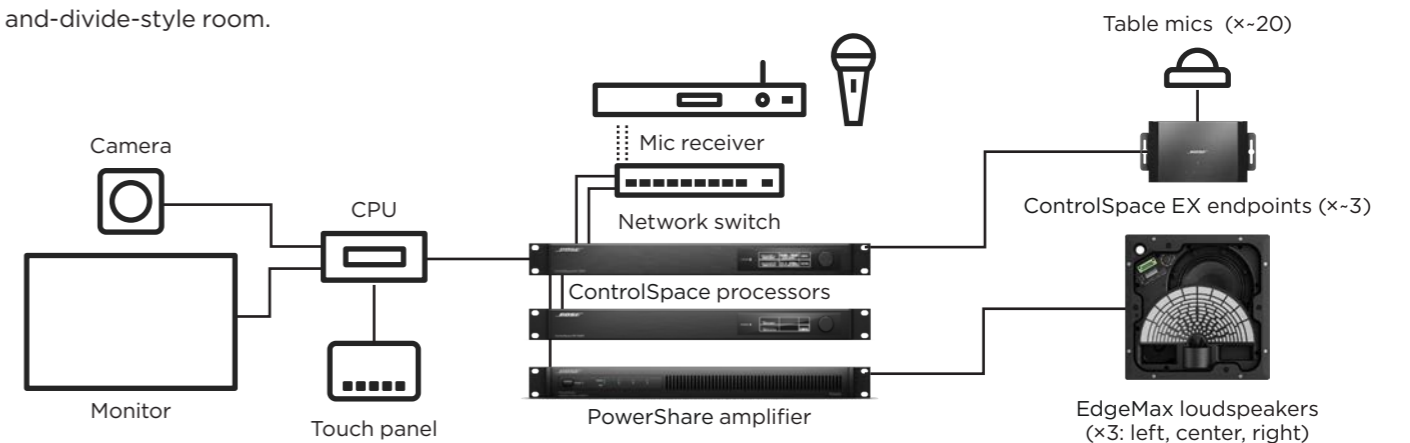

*Bose and Sennheiser products sold separately. Please contact your Bose or Sennheiser representative for more information.



Clutter-free meetings

Bose Work & Barco Clickshare

Combine the Barco ClickShare CX-30 with the Bose Videobar VB-S or VB1 for huddle spaces and small- to medium-sized conference rooms — an ideal solution for getting meeting rooms up and running quickly.

For larger meeting rooms, combine the ClickShare CX-50 with either the Bose ES1 or DS4 ceiling audio solutions.



Barco ClickShare CX-50 and CX-30 with buttons



Simple clarity. Complete control.

Bose Work & HP conferencing solutions

Combine Bose Work products — including Bose VB-S, VB1, ES1, and DS4 solutions — with the HP Elite Slice G2 Audio Ready with Microsoft Teams Rooms or Zoom Rooms.

For large meeting rooms, the HP Elite Slice G2 Audio Ready can be combined with either the Bose ES1 or DS4 ceiling audio solution.



HP Elite Slice G2 Audio Ready



Unify the in-room and remote meeting experience

Bose Work & Solstice Conference from Mersive

Solstice Conference combines with the Bose Videobar VB-S or VB1 to enhance video conferencing with rich, multi-participant content sharing. Make any room a Zoom, Teams, and WebEx room by wirelessly connecting the conferencing services on users' laptops to the room technology for more seamless, productive meetings between onsite and remote participants.

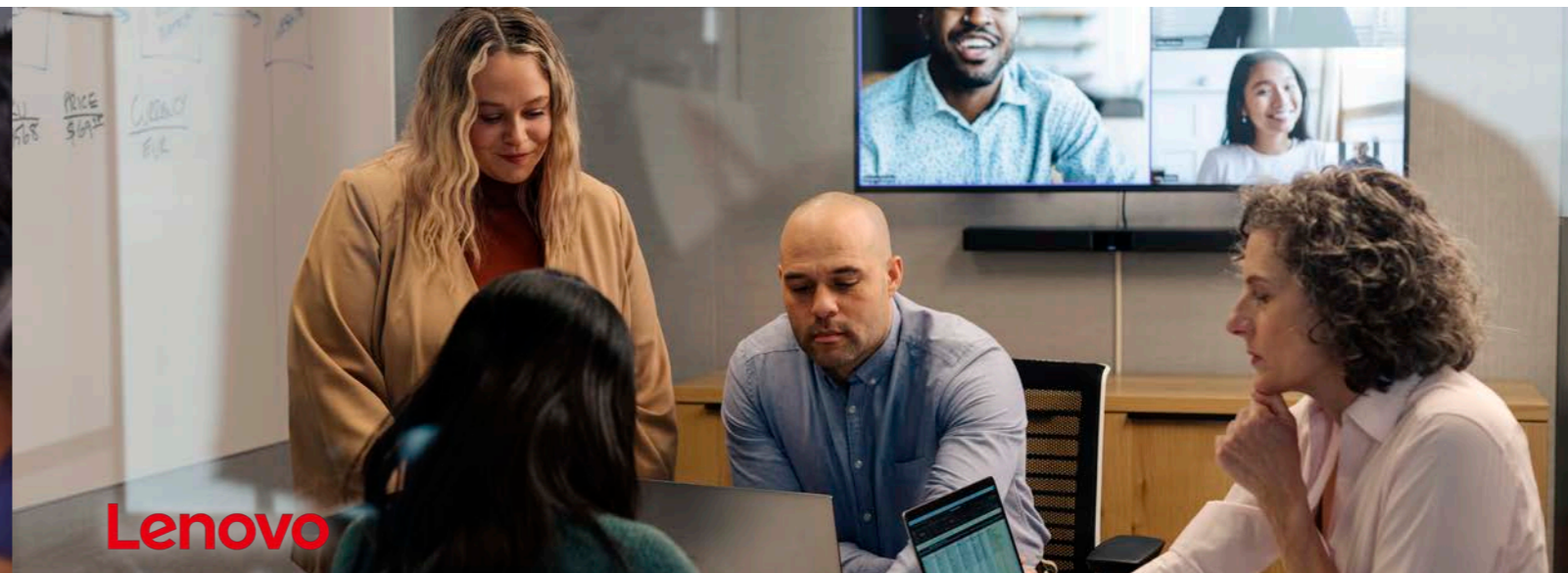

Intelligent conferencing

Bose Work & Lenovo™ ThinkSmart™ solutions

Combine the Bose VB-S or VB1 with Lenovo ThinkSmart Core + ThinkSmart Controller for powerful, streamlined meeting room setups with sleek component design.

For larger rooms, the Lenovo ThinkSmart Core + Controller can be combined with either the Bose ES1 or DS4 ceiling audio solution.



Lenovo ThinkSmart Core + Controller



Bose has joined the call.

Bring the simplicity and clarity of Bose to all of your meeting spaces — with all-in-one USB innovations for meeting rooms, desktop and mobile conferencing products, and fully integrated conferencing systems. **Bose Work** solutions help everyone hear more, see more, understand more, and work better.

PARTNER WITH US

With a global presence, including subsidiaries in 25 countries and comprehensive training — both online and in-person — we're ready to partner with you.

CONTACT US TODAY

To learn more about the full range of Bose conferencing solutions, contact us:
[PRO.BOSE.COM/contact](https://pro.bose.com/contact)

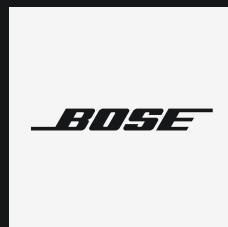

[PRO.BOSE.COM](https://pro.bose.com)

© 2022 Bose Corporation.

Bose, Videobar, Bose Work, Bose Noise Cancelling Headphones, ControlSpace, PowerSpace, EdgeMax, and DesignMax are trademarks of Bose Corporation. Sennheiser, Microsoft Teams, Google Meet, Google Voice, Zoom, *Bluetooth*, HDMI, VESA, Dante, Mersive, Solstice, Barco ClickShare CX-30, Barco ClickShare CX-50, HP Elite Slice G2 Audio Ready, Lenovo, and ThinkSmart are registered trademarks of their respective owners. 03/2022

Product images and system examples not to scale.